

Dell WYSE Thin Client Bracket



This adjustable bracket has been specially developed to maximise ease of access and ergonomic flexibility for the popular range of Dell WYSE thin client computers. The bracket allows the thin client to be conveniently placed behind the monitor, so it may be moved in tandem with the monitor and easily accessed from the desktop, whilst being concealed behind the monitor and out of the way.

Removing the thin client from the desktop provides a much smaller equipment footprint, frees up desk space, and simplifies IT access.

- Attaches “sandwich style” between the monitor and the monitor arm.
- Adjustable casing allows devices to be held securely, facilitates ease of access, and caters for different sized devices.
- Pre-configured for easy attachment - suits 75 and 100mm VESA screw mount pattern.
- Perforations on the bracket match the Dell device perfectly to allow for airflow.
- Generous port-holes provide easy cable access.
- For use with 7Flex or other Uplifting monitor arms.



Thin client bracket closed



Thin client bracket empty

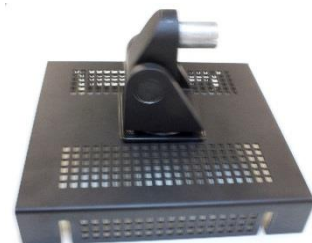

Thin client bracket with Uplifting 7Flex monitor arm tilter attached

Dell WYSE Thin Client Bracket

Product Code: 80156-000-29

Instructions

- Step 1 Unscrew the 4 adjustment knobs from the sides of the bracket case.



- Step 2 Take the two cases apart.

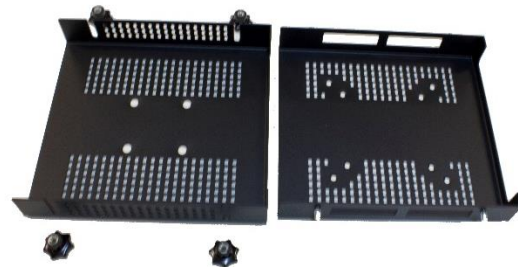

- Step 3 Attach the case with the 50mm square pre-drilled mount pattern to the monitor tilter with the four (4) 10-32 x 3/8" Phillips pan head silver screws and washers.
(Screws supplied with the Uplifting monitor arm and washers supplied with the bracket).

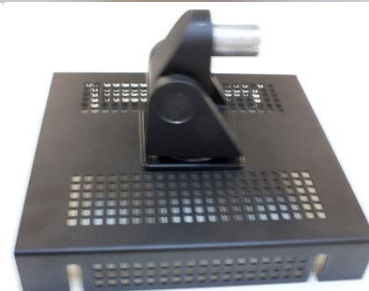
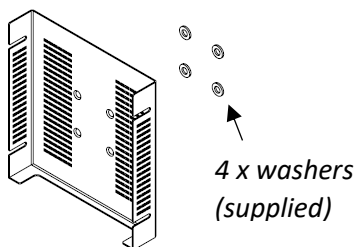

- Step 4 Attach the other case with the VESA predrilled holes (75 and 100mm) to the monitor with the four M4 x 20mm Phillips pan head black screws. (Screws supplied with the bracket).

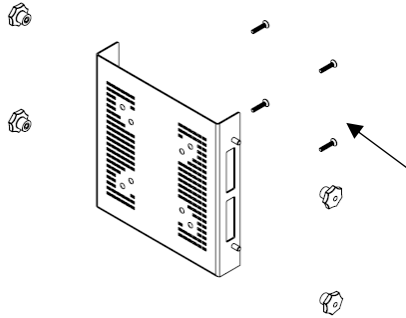

4 x M4 x 20mm screws
to attach to the
monitor (*supplied*)



- NOTE: All Uplifting monitor arms come complete with a VESA plate (see photo) and have sufficient screws enclosed in the packaging box to use for both the monitor arm and monitor attachment. The use of this plate is not necessary when attaching a Thin Client Bracket.



- Step 5 Place the device inside the case then place the two sides together and tighten the knobs to the desired position



Step 7 The monitor can now be placed onto the monitor arm and adjusted to the desired height.

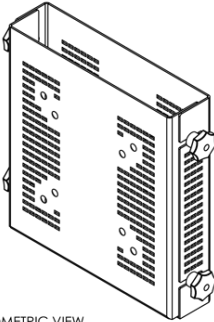

ISOMETRIC VIEW

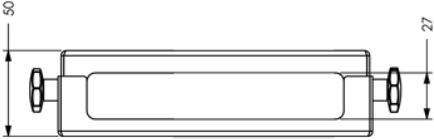

UNDERSIDE
(MAXIMUM)

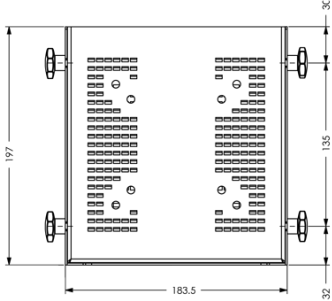

FRONT VIEW